



5th-Order, Lowpass, Elliptic, Switched-Capacitor Filters

MAX7426/MAX7427

General Description

The MAX7426/MAX7427 5th-order, lowpass, elliptic, switched-capacitor filters (SCFs) operate from a single +5V (MAX7426) or +3V (MAX7427) supply. The devices draw only 0.8mA of supply current and allow corner frequencies from 1Hz to 12kHz, making them ideal for low-power post-DAC filtering and anti-aliasing applications. They can be put into a low-power mode, reducing supply current to 0.2µA.

Two clocking options are available: self-clocking (through the use of an external capacitor) or external clocking for tighter cutoff-frequency control. An offset-adjust pin allows for adjustment of the DC output level.

The MAX7426/MAX7427 deliver 37dB of stopband rejection and a sharp rolloff with a transition ratio of 1.25. Their fixed response limits the design task to selecting a clock frequency.

Applications

ADC Anti-Aliasing CT2 Base Stations
 Post-DAC Filtering Speech Processing

Selector Guide

PART	TRANSITION RATIO	OPERATING VOLTAGE (V)
MAX7426	r = 1.25	+5
MAX7427	r = 1.25	+3

Features

- ◆ 5th-Order, Elliptic Lowpass Filters
- ◆ Low Noise and Distortion: -80dB THD + Noise
- ◆ Clock-Tunable Corner Frequency (1Hz to 12kHz)
- ◆ Single-Supply Operation
 - +5V (MAX7426)
 - +3V (MAX7427)
- ◆ Low Power
 - 0.8mA (Operating Mode)
 - 0.2µA (Shutdown Mode)
- ◆ Available in 8-Pin µMAX/PDIP Packages
- ◆ Low Output Offset: ±4mV

Ordering Information

PART	TEMP. RANGE	PIN-PACKAGE
MAX7426CUA	0°C to +70°C	8 µMAX
MAX7426CPA	0°C to +70°C	8 Plastic DIP
MAX7426EUA	-40°C to +85°C	8 µMAX
MAX7426EPA	-40°C to +85°C	8 Plastic DIP
MAX7427CUA	0°C to +70°C	8 µMAX
MAX7427CPA	0°C to +70°C	8 Plastic DIP
MAX7427EUA	-40°C to +85°C	8 µMAX
MAX7427EPA	-40°C to +85°C	8 Plastic DIP

Typical Operating Circuit

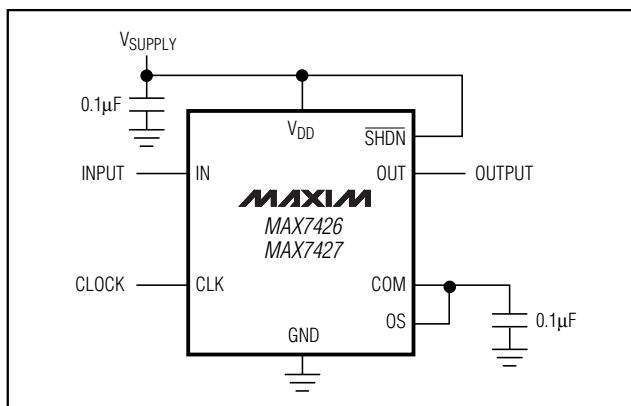

Pin Configuration

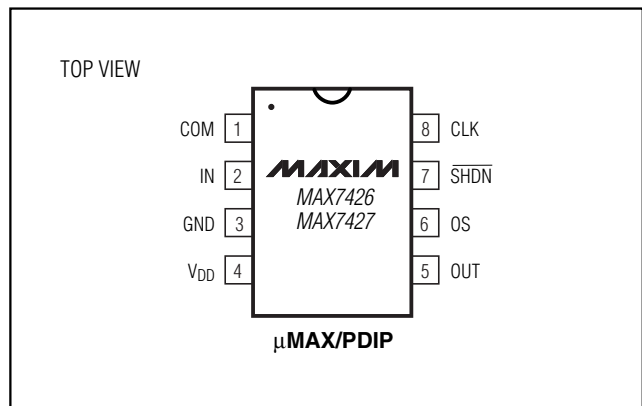

5th-Order, Lowpass, Elliptic, Switched-Capacitor Filters

ABSOLUTE MAXIMUM RATINGS

V _{DD} to GND	-0.3V to +6V
IN, OUT, COM, OS, CLK, $\overline{\text{SHDN}}$	-0.3V to (V _{DD} + 0.3V)
OUT Short-Circuit Duration	1s
Continuous Power Dissipation (T _A = +70°C)	
8-Pin μ MAX (derate 4.1mW/°C above +70°C)	330mW
8-Pin PDIP (derate 6.90mW/°C above +70°C)	552mW

Operating Temperature Ranges

MAX742_C_A	0°C to +70°C
MAX742_E_A	-40°C to +85°C
Storage Temperature Range	-65°C to +160°C
Lead Temperature (soldering, 10s)	+300°C

Stresses beyond those listed under "Absolute Maximum Ratings" may cause permanent damage to the device. These are stress ratings only, and functional operation of the device at these or any other conditions beyond those indicated in the operational sections of the specifications is not implied. Exposure to absolute maximum rating conditions for extended periods may affect device reliability.

ELECTRICAL CHARACTERISTICS—MAX7426

(V_{DD} = +5V, filter output measured at OUT, 10k Ω || 50pF load to GND at OUT, $\overline{\text{SHDN}}$ = V_{DD}, OS = COM, 0.1 μ F from COM to GND, f_{CLK} = 100kHz, T_A = T_{MIN} to T_{MAX}, unless otherwise noted. Typical values are at T_A = +25°C.)

PARAMETER	SYMBOL	CONDITIONS	MIN	TYP	MAX	UNITS
FILTER						
Corner-Frequency Range	f _C	(Note 1)		0.001 to 9		kHz
Clock-to-Corner Ratio	f _{CLK} /f _C			100:1		
Clock-to-Corner Tempco				10		ppm/°C
Output Voltage Range			0.25		V _{DD} - 0.25	V
Output Offset Voltage	V _{OFFSET}	V _{IN} = V _{COM} = V _{DD} / 2		±4	±25	mV
DC Insertion Gain with Output Offset Removed		V _{COM} = V _{DD} / 2 (Note 2)	0	0.2	0.4	dB
Total Harmonic Distortion plus Noise	THD+N	f _{IN} = 200Hz, V _{IN} = 4Vp-p, measurement bandwidth = 22kHz		-81		dB
Offset Voltage Gain	A _{OS}	OS to OUT		+1		V/V
COM Voltage Range	V _{COM}	Input, COM externally driven	$\frac{V_{DD}}{2} - 0.5$	$\frac{V_{DD}}{2}$	$\frac{V_{DD}}{2} + 0.5$	V
		Output, COM internally driven	$\frac{V_{DD}}{2} - 0.2$	$\frac{V_{DD}}{2}$	$\frac{V_{DD}}{2} + 0.2$	
Input Voltage Range at OS	V _{OS}	Measured with respect to COM		±0.1		V
Input Resistance at COM	R _{COM}		90	130		k Ω
Clock Feedthrough		T _A = +25°C		5		mVp-p
Resistive Output Load Drive	R _L		10	1		k Ω
Maximum Capacitive Load at OUT	C _L		50	500		pF
Input Leakage Current at COM		$\overline{\text{SHDN}}$ = GND, V _{COM} = 0 to V _{DD}		±0.2	±10	μ A
Input Leakage Current at OS		V _{OS} = 0 to V _{DD}		±0.2	±10	μ A
CLOCK						
Internal Oscillator Frequency	f _{OSC}	C _{OSC} = 1000pF (Note 3)	13.5	17.5	21.5	kHz
Clock Output Current (internal oscillator mode)	I _{CLK}			±8	±12.5	μ A
Clock Input High	V _{IH}		4.5			V
Clock Input Low	V _{IL}				0.5	V

5th-Order, Lowpass, Elliptic, Switched-Capacitor Filters

MAX7426/MAX7427

ELECTRICAL CHARACTERISTICS—MAX7426 (continued)

($V_{DD} = +5V$, filter output measured at OUT, $10k\Omega \parallel 50pF$ load to GND at OUT, $\overline{SHDN} = V_{DD}$, OS = COM, $0.1\mu F$ from COM to GND, $f_{CLK} = 100kHz$, $T_A = T_{MIN}$ to T_{MAX} , unless otherwise noted. Typical values are at $T_A = +25^\circ C$.)

PARAMETER	SYMBOL	CONDITIONS	MIN	TYP	MAX	UNITS
POWER REQUIREMENTS						
Supply Voltage	V_{DD}		4.5		5.5	V
Supply Current	I_{DD}	Operating mode, no load		0.8	1.0	mA
Shutdown Current	$I_{\overline{SHDN}}$	$\overline{SHDN} = GND$		0.2	1	μA
Power-Supply Rejection Ratio	PSRR	Measured at DC		70		dB
SHUTDOWN						
\overline{SHDN} Input High	V_{SDH}		4.5			V
\overline{SHDN} Input Low	V_{SDL}				0.5	V
\overline{SHDN} Input Leakage Current		$V_{\overline{SHDN}} = 0$ to V_{DD}		± 0.2	± 10	μA

ELECTRICAL CHARACTERISTICS—MAX7427

($V_{DD} = +3V$, filter output measured at OUT pin, $10k\Omega \parallel 50pF$ load to GND at OUT, $\overline{SHDN} = V_{DD}$, OS = COM, $0.1\mu F$ from COM to GND, $f_{CLK} = 100kHz$, $T_A = T_{MIN}$ to T_{MAX} , unless otherwise noted. Typical values are at $T_A = +25^\circ C$.)

PARAMETER	SYMBOL	CONDITIONS	MIN	TYP	MAX	UNITS
FILTER CHARACTERISTICS						
Corner-Frequency Range	f_c	(Note 1)		0.001 to 12		kHz
Clock-to-Corner Ratio	f_{CLK}/f_c			100:1		
Clock-to-Corner Tempco				10		ppm/ $^\circ C$
Output Voltage Range			0.25		$V_{DD} - 0.25$	V
Output Offset Voltage	V_{OFFSET}	$V_{IN} = V_{COM} = V_{DD} / 2$		± 4	± 25	mV
DC Insertion Gain with Output Offset Removed		$V_{COM} = V_{DD} / 2$ (Note 2)	0	0.2	0.4	dB
Total Harmonic Distortion plus Noise	THD+N	$f_{IN} = 200Hz$, $V_{IN} = 2.5V_{p-p}$, measurement bandwidth = 22kHz		-79		dB
Offset Voltage Gain	AOS	OS to OUT		+1		V/V
COM Voltage Range	V_{COM}		$\frac{V_{DD}}{2} - 0.1$	$\frac{V_{DD}}{2}$	$\frac{V_{DD}}{2} + 0.1$	V
Input Voltage Range at OS	V_{OS}	Measured with respect to COM		± 0.1		V
Input Resistance at COM	R_{COM}		90	130		$k\Omega$
Clock Feedthrough		$T_A = +25^\circ C$		3		mV _{p-p}
Resistance Output Load Drive	R_L		10	1		$k\Omega$
Maximum Capacitive Load at OUT	C_L		50	500		pF
Input Leakage Current at COM		$\overline{SHDN} = GND$, $V_{COM} = 0$ to V_{DD}		± 0.2	± 10	μA
Input Leakage Current at OS		$V_{OS} = 0$ to V_{DD}		± 0.2	± 10	μA

5th-Order, Lowpass, Elliptic, Switched-Capacitor Filters

ELECTRICAL CHARACTERISTICS—MAX7427 (continued)

($V_{DD} = +3V$, filter output measured at OUT pin, $10k\Omega$ || $50pF$ load to GND at OUT, $\overline{SHDN} = V_{DD}$, OS = COM, $0.1\mu F$ from COM to GND, $f_{CLK} = 100kHz$, $T_A = T_{MIN}$ to T_{MAX} , unless otherwise noted. Typical values are at $T_A = +25^\circ C$.)

PARAMETER	SYMBOL	CONDITIONS	MIN	TYP	MAX	UNITS
CLOCK						
Internal Oscillator Frequency	f_{OSC}	$C_{OSC} = 1000pF$ (Note 3)	13.5	17.5	21.5	kHz
Clock Output Current (internal oscillator mode)	I_{CLK}	$V_{CLK} = 0$ or $3V$		± 7.5	± 12.5	μA
Clock Input High	V_{IH}		2.5			V
Clock Input Low	V_{IL}				0.5	V
POWER REQUIREMENTS						
Supply Voltage	V_{DD}		2.7		3.6	V
Supply Current	I_{DD}	Operating mode, no load		0.75	1.0	mA
Shutdown Current	$I_{\overline{SHDN}}$	$\overline{SHDN} = GND$		0.2	1	μA
Power-Supply Rejection Ratio	PSRR	Measured at DC		70		dB
SHUTDOWN						
\overline{SHDN} Input High	V_{SDH}		2.5			V
\overline{SHDN} Input Low	V_{SDL}				0.5	V
\overline{SHDN} Input Leakage Current		$V_{\overline{SHDN}} = 0$ to V_{DD}		± 0.2	± 10	μA

ELLIPTIC FILTER CHARACTERISTICS ($r = 1.25$)

($V_{DD} = +5V$ for MAX7426, $V_{DD} = +3V$ for MAX7427, filter output measured at OUT, $10k\Omega$ || $50pF$ load to GND at OUT, $\overline{SHDN} = V_{DD}$, $V_{COM} = V_{OS} = V_{DD} / 2$, $f_{CLK} = 100kHz$, $T_A = T_{MIN}$ to T_{MAX} , unless otherwise noted. Typical values are at $T_A = +25^\circ C$.) (Note 3)

PARAMETER	CONDITIONS	MIN	TYP	MAX	UNITS
Insertion Gain with DC Gain Error Removed (Note 4)	$f_{IN} = 0.38f_C$	-0.4	-0.2	0.4	dB
	$f_{IN} = 0.68f_C$	-0.4	0.2	0.4	
	$f_{IN} = 0.87f_C$	-0.4	-0.2	0.4	
	$f_{IN} = 0.97f_C$	-0.4	0.2	0.4	
	$f_{IN} = f_C$	-0.7	-0.2	0.2	
	$f_{IN} = 1.25f_C$		-38.5	-34	
	$f_{IN} = 1.43f_C$		-37.2	-35	
	$f_{IN} = 3.25f_C$		-37.2	-35	

Note 1: The maximum f_C is defined as the clock frequency $f_{CLK} = 100 \times f_C$ at which the peak SINAD drops to 68dB with a sinusoidal input at $0.2f_C$.

Note 2: DC insertion gain is defined as $\Delta V_{OUT} / \Delta V_{IN}$.

Note 3: f_{OSC} (kHz) $\approx 17.5 \times 10^3 / C_{OSC}$ (C_{OSC} in pF).

Note 4: The input frequencies, f_{IN} , are selected at the peaks and troughs of the ideal elliptic frequency responses.

5th-Order, Lowpass, Elliptic, Switched-Capacitor Filters

Typical Operating Characteristics

($V_{DD} = +5V$ for MAX7426, $V_{DD} = +3V$ for MAX7427, $f_{CLK} = 100kHz$, $\overline{SHDN} = V_{DD}$, $V_{COM} = V_{OS} = V_{DD} / 2$, $T_A = +25^\circ C$, unless otherwise noted.)

MAX7426/MAX7427

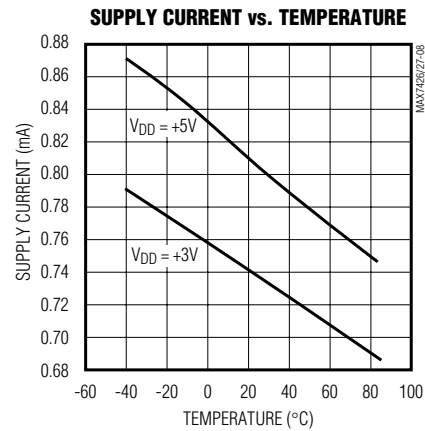
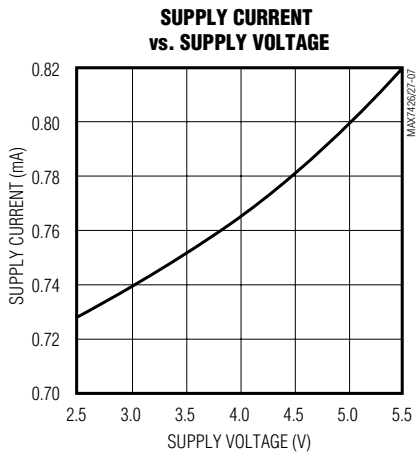
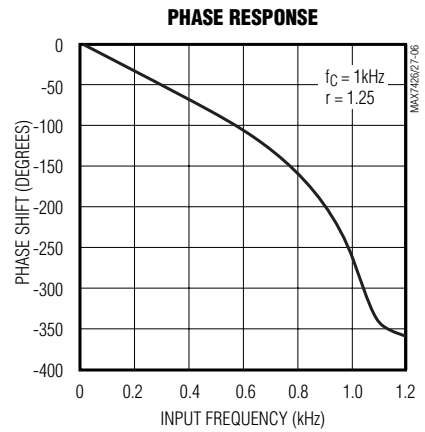
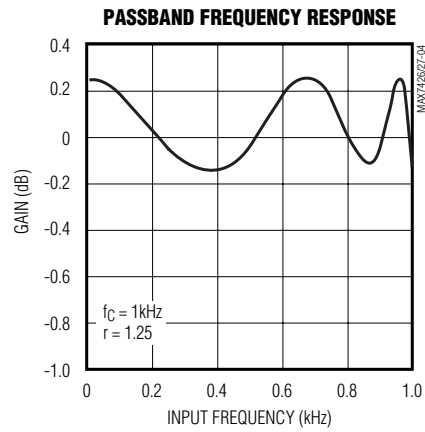
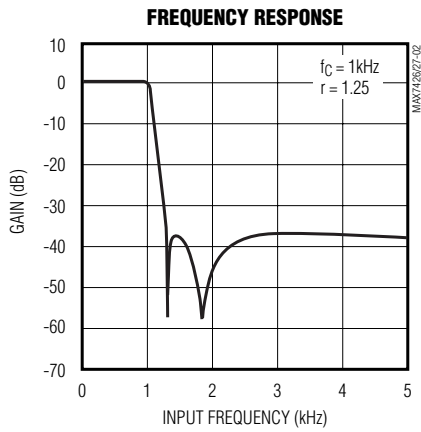

5th-Order, Lowpass, Elliptic, Switched-Capacitor Filters

Typical Operating Characteristics (continued)

($V_{DD} = +5V$ for MAX7426, $V_{DD} = +3V$ for MAX7427, $f_{CLK} = 100kHz$, $\overline{SHDN} = V_{DD}$, $V_{COM} = V_{OS} = V_{DD} / 2$, $T_A = +25^\circ C$, unless otherwise noted.)

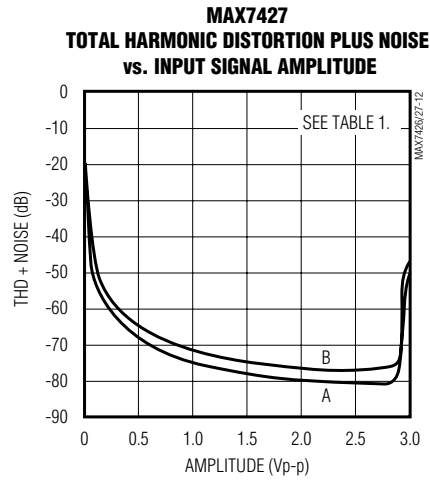
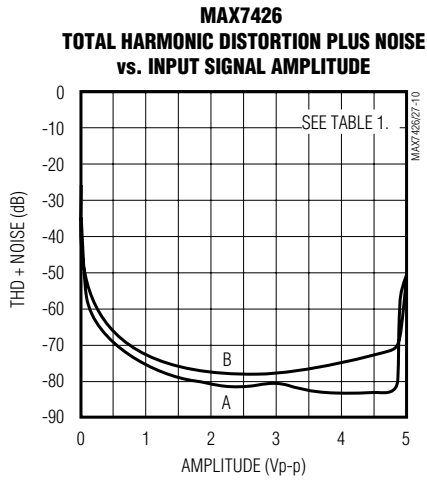

Table 1. THD + Noise Test Conditions

LABEL	f_{IN} (Hz)	f_c (kHz)	f_{CLK} (kHz)	MEASUREMENT BANDWIDTH (kHz)
A	200	1	100	22
B	1k	5	500	80

5th-Order, Lowpass, Elliptic, Switched-Capacitor

MAX7426/MAX7427

Typical Operating Characteristics (continued)

($V_{DD} = +5V$ for MAX7426, $V_{DD} = +3V$ for MAX7427, $f_{CLK} = 100kHz$, $\overline{SHDN} = V_{DD}$, $V_{COM} = V_{OS} = V_{DD} / 2$, $T_A = +25^\circ C$, unless otherwise noted.)

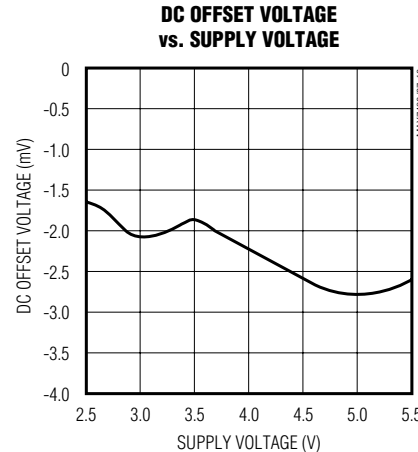
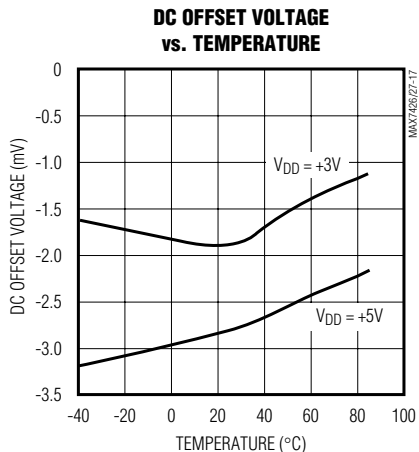
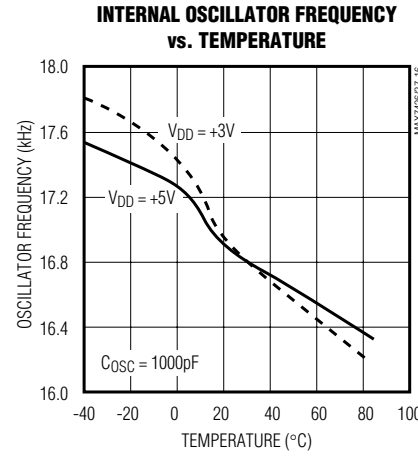
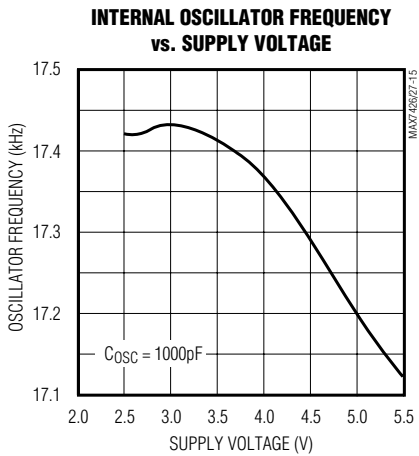
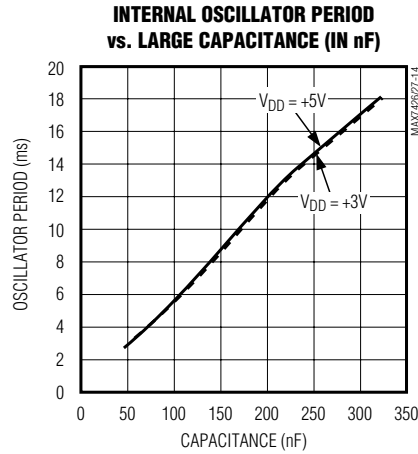
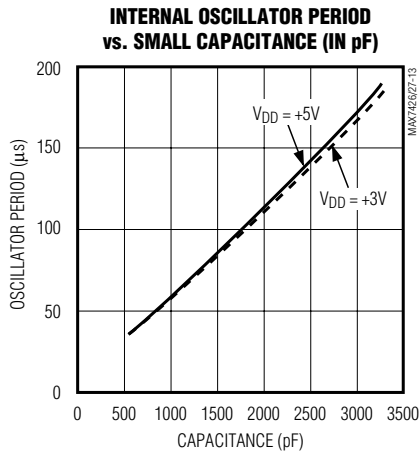

5th-Order, Lowpass, Elliptic, Switched-Capacitor Filters

Pin Description

PIN	NAME	FUNCTION
1	COM	Common Input Pin. Biased internally at midsupply. Bypass externally to GND with a 0.1 μ F capacitor. To override internal biasing, drive with an external supply.
2	IN	Filter Input
3	GND	Ground
4	V _{DD}	Positive Supply Input, +5V for MAX7426 or +3V for MAX7427
5	OUT	Filter Output
6	OS	Offset Adjust Input. To adjust output offset, bias OS with a resistive voltage-divider between an external supply and ground. Connect OS to COM if no offset adjustment is needed.
7	$\overline{\text{SHDN}}$	Shutdown Input. Drive low to enable shutdown mode; drive high or connect to V _{DD} for normal operation.
8	CLK	Clock Input. Connect an external capacitor (C _{OSC}) from CLK to GND to set the internal oscillator frequency. To override the internal oscillator, connect to an external clock.

Detailed Description

The MAX7426/MAX7427 family of 5th-order, elliptic, lowpass filters provides sharp rolloff with good stopband rejection. All parts operate with a 100:1 clock-to-corner frequency ratio.

Most SCFs are designed with biquadratic sections. Each section implements two pole-zero pairs, and the sections can be cascaded to produce higher-order filters. The advantage to this approach is ease of design. However, this type of design is highly sensitive to component variations if any section's Q is high. The MAX7426/MAX7427 use an alternative approach, which is to emulate a passive network using switched-capacitor integrators with summing and scaling. The passive network may be synthesized using CAD programs or may be found in many filter books. Figure 1 shows a basic 5th-order ladder elliptic filter structure.

A switched-capacitor filter that emulates a passive ladder filter retains many of the same advantages. The component sensitivity of a passive ladder filter is low when compared to a cascaded biquadratic design, because each component affects the entire filter shape rather than a single pole-zero pair. In other words, a

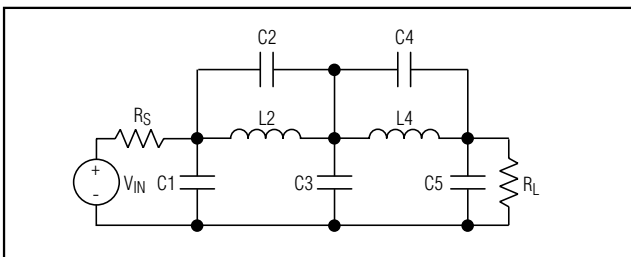

Figure 1. 5th-Order Ladder Elliptic Filter Network

mismatched component in a biquadratic design has a concentrated error on its respective poles, while the same mismatch in a ladder filter design spreads its error over all poles.

Elliptic Characteristics

Lowpass elliptic filters such as the MAX7426/MAX7427 provide the steepest possible rolloff with frequency of the four most common filter types (Butterworth, Bessel, Chebyshev, and elliptic). The high Q value of the poles near the passband edge combined with the stopband zeros allow for the sharp attenuation characteristic of elliptic filters, making these devices ideal for anti-aliasing and post-DAC filtering in single-supply systems (see the *Anti-Aliasing and Post-DAC Filtering* section).

In the frequency domain (Figure 2), the first transmission zero causes the filter's amplitude to drop to a minimum level. Beyond this zero, the response rises as the frequency increases until the next transmission zero. The stopband begins at the stopband frequency, f_s . At frequencies above f_s , the filter's gain does not exceed the gain at f_s . The corner frequency, f_c , is defined as the point where the filter output attenuation falls just below the passband ripple. The transition ratio (r) is defined as the ratio of the stopband frequency to the corner frequency:

$$r = f_s / f_c$$

The MAX7426/MAX7427 have a transition ratio of 1.25 and typically 37dB of stopband rejection.

Clock Signal

External Clock

These SCFs are designed for use with external clocks that have a 40% to 60% duty cycle. When using an external clock, drive the CLK pin with a CMOS gate

5th-Order, Lowpass, Elliptic, Switched-Capacitor Filters

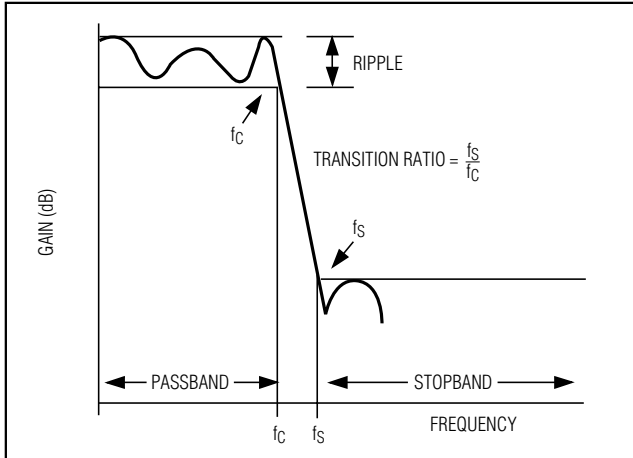

Figure 2. Elliptic Filter Response

powered from 0 to V_{DD} . Varying the rate of the external clock adjusts the corner frequency of the filter:

$$f_c = \frac{f_{CLK}}{100}$$

Internal Clock

When using the internal oscillator, the capacitance (C_{OSC}) on CLK determines the oscillator frequency:

$$f_{OSC}(\text{kHz}) = \frac{17.5 \times 10^3}{C_{OSC}(\text{pF})}$$

Since C_{OSC} is in the low picofarads, minimize the stray capacitance at CLK so that it does not affect the internal oscillator frequency. Varying the rate of the internal oscillator adjusts the filter's corner frequency by a 100:1 clock-to-corner frequency ratio. For example, an internal oscillator frequency of 100kHz produces a nominal corner frequency of 1kHz.

Input Impedance vs. Clock Frequencies

The MAX7426/MAX7427's input impedance is effectively that of a switched-capacitor resistor (see the following equation), and is inversely proportional to frequency. The input impedance values determined by the equation represent the average input impedance, since the input current is not continuous. As a rule, use a driver with an output resistance less than 10% of the filter's input impedance.

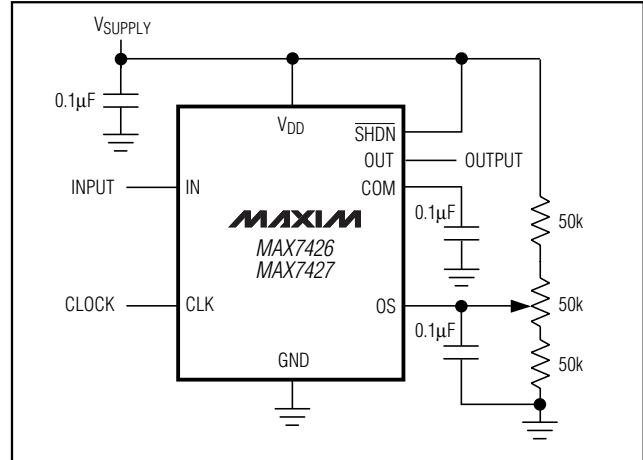

Figure 3. Offset Adjustment Circuit

Estimate the input impedance of the filter by using the following formula:

$$Z_{IN} = \frac{1}{f_{CLK} \times C_{IN}}$$

where f_{CLK} = clock frequency and C_{IN} = 1pF.

Low-Power Shutdown Mode

The MAX7426/MAX7427 have a shutdown mode that is activated by driving \overline{SHDN} low. In shutdown mode, the filter supply current reduces to 0.2µA, and the output of the filter becomes high impedance. For normal operation, drive \overline{SHDN} high or connect to V_{DD} .

Applications Information

Offset (OS) and Common-Mode (COM) Input Adjustment

COM sets the common-mode input voltage and is biased at midsupply with an internal resistor-divider. If the application does not require offset adjustment, connect OS to COM. For applications where offset adjustment is required, apply an external bias voltage through a resistor-divider network to OS, as shown in Figure 3. For applications that require DC level shifting, adjust OS with respect to COM. (**Note:** Do not leave OS unconnected.) The output voltage is represented by these equations:

$$V_{OUT} = (V_{IN} - V_{COM}) + V_{OS}$$

$$V_{COM} = \frac{V_{DD}}{2} \text{ (typical)}$$

where $(V_{IN} - V_{COM})$ is lowpass filtered by the SCF and OS is added at the output stage. See the *Electrical*

5th-Order, Lowpass, Elliptic, Switched-Capacitor Filters

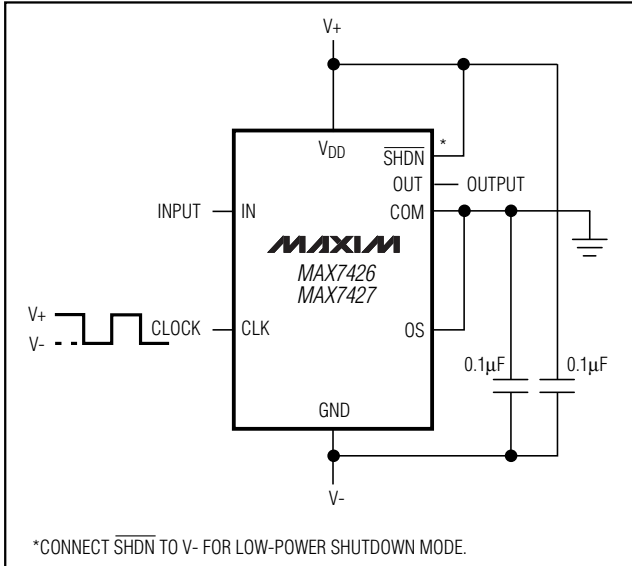

Figure 4. Dual-Supply Operation

Characteristics table for the input voltage range of COM and OS. Changing the voltage on COM or OS significantly from midsupply reduces the dynamic range.

Power Supplies

The MAX7426 operates from a single +5V supply, and the MAX7427 operates from a single +3V supply. Bypass V_{DD} to GND with a 0.1µF capacitor. If dual supplies are required, connect COM to the system ground and GND to the negative supply. Figure 4 shows an example of dual-supply operation. Single-supply and dual-supply performance are equivalent.

For either single-supply or dual-supply operation, drive CLK and SHDN from GND (V₋ in dual-supply operation) to V_{DD}. Use the MAX7427 for ±2.5, and use the MAX7426 for ±1.5V. For ±5V dual-supply applications, refer to the MAX291/MAX292/MAX295/MAX296 and MAX293/MAX294/MAX297 data sheets.

Input Signal Amplitude Range

The optimal input signal range is determined by observing the voltage level at which the signal-to-noise plus distortion (SINAD) ratio is maximized for a given corner frequency. The *Typical Operating Characteristics* show the THD + Noise response as the input signal's peak-to-peak amplitude is varied.

Anti-Aliasing and Post-DAC Filtering

When using the MAX7426/MAX7427 for anti-aliasing or post-DAC filtering, synchronize the DAC (or ADC) and the filter clocks. If the clocks are not synchronized, beat frequencies may alias into the desired passband.

Harmonic Distortion

Harmonic distortion arises from nonlinearities within the filter. These nonlinearities generate harmonics when a pure sine wave is applied to the filter input. Table 2 lists typical harmonic distortion values with a 10kΩ load at T_A = +25°C.

Chip Information

TRANSISTOR COUNT: 1457
PROCESS: BiCMOS

Table 2. Typical Harmonic Distortion

FILTER	f _{CLK} (kHz)	f _{IN} (Hz)	V _{IN} (V _{p-p})	TYPICAL HARMONIC DISTORTION (dB)			
				2nd	3rd	4th	5th
MAX7426	500	1k	4	-71	-73	-90	-82
	100	200		-88	-86	-92	-88
MAX7427	500	1k	2	-87	-86	-90	-90
	100	200		-90	-87	-90	-90

5th-Order, Lowpass, Elliptic, Switched-Capacitor Filters

Package Information

MAX7426/MAX7427

8LUMAXD.EPS

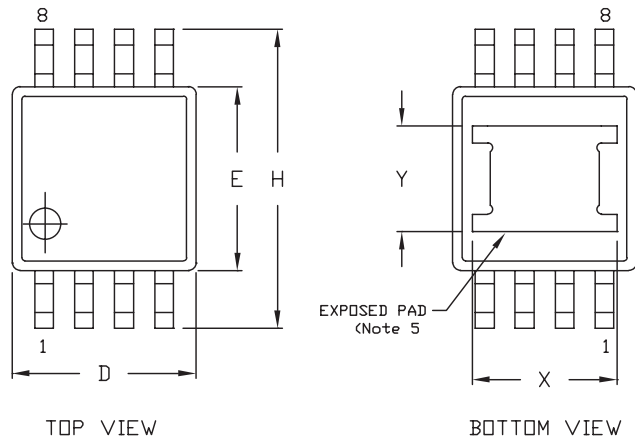

	INCHES		MILLIMETERS		JEDEC			
	MIN	MAX	MIN	MAX	MIN	MAX	MIN	MAX
A	0.037	0.043	0.94	1.10	---	0.043	---	1.10
A1	0.002	0.006	0.05	0.15	0.002	0.006	0.05	0.15
B	0.010	0.014	0.25	0.36	0.010	0.016	0.25	0.40
C	0.005	0.007	0.13	0.18	0.005	0.009	0.13	0.23
D	0.116	0.120	2.95	3.05	0.114	0.122	2.9	3.1
e	0.0256 BSC		0.65 BSC		0.0256 BSC		0.64 BSC	
E	0.116	0.120	2.95	3.05	0.114	0.122	2.9	3.1
H	0.188	0.198	4.78	5.03	0.193 BSC		4.9 BSC	
L	0.016	0.026	0.41	0.66	0.016	0.027	0.40	0.70
α	0°	6°	0°	6°	0°	6°	0°	6°
*X	0.087	0.099	2.210	2.515				
*Y	0.062	0.074	1.575	1.880				

* EXPOSED PAD (Note 5)

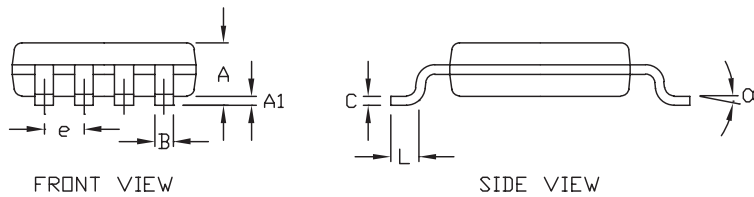

NOTES:

1. D & E DO NOT INCLUDE MOLD FLASH.
2. MOLD FLASH OR PROTRUSIONS NOT TO EXCEED .15 MM (.006").
3. CONTROLLING DIMENSION: MILLIMETERS.
4. MEETS JEDEC MO-187.
5. DIMENSIONS X & Y APPLY TO EXPOSED PAD (EP) VERSIONS ONLY. SEE INDIVIDUAL PRODUCT DATASHEET TO DETERMINE IF A PRODUCT USES EXPOSED PAD PACKAGE.
6. EXPOSED PAD FLUSH WITH BOTTOM OF PACKAGE WITHIN .002".

MAXIM			
<small>PROPRIETARY INFORMATION</small>			
<small>TITLE:</small>			
<small>PACKAGE OUTLINE, 8L uMAX WITH EP OPTION</small>			
<small>APPROVAL:</small>	<small>DOCUMENT CONTROL NO.:</small>	<small>REV:</small>	
	21-0036	H	1/1

5th-Order, Lowpass, Elliptic, Switched-Capacitor Filters

Package Information (continued)

PDIPN:EPS

	INCHES		MILLIMETERS	
	MIN	MAX	MIN	MAX
A	---	0.180	---	4.572
A1	0.020	---	0.508	---
A2	0.125	0.175	3.18	4.45
A3	0.055	0.080	1.40	2.03
B	0.015	0.021	0.381	0.533
B1	0.045	0.060	1.14	1.524
C	0.009	0.014	0.229	0.355
D1	0.005	0.080	0.13	2.03
E	0.300	0.325	7.62	8.255
E1	0.275	0.295	6.985	7.493
e	0.100	---	2.54	---
eA	0.300	---	7.62	---
eB	---	0.400	---	10.16
L	0.115	0.150	2.921	3.81

	INCHES		MILLIMETERS		N	MS001
	MIN	MAX	MIN	MAX		
D	0.348	0.390	8.84	9.91	8	AB
D	0.735	0.765	18.67	19.43	14	AC
D	0.745	0.765	18.92	19.43	16	AA
D	0.885	0.915	22.48	23.24	18	AD
D	1.015	1.045	25.78	26.54	20	AE
D	1.14	1.265	28.96	32.13	24	AF
D	1.360	1.380	34.54	35.05	28	*5

NOTES:
 1. D&E DO NOT INCLUDE MOLD FLASH
 2. MOLD FLASH OR PROTRUSIONS NOT TO EXCEED .15mm (.006")
 3. CONTROLLING DIMENSION: MILLIMETER
 4. MEETS JEDEC MS001-XX AS SHOWN IN ABOVE TABLE
 5. SIMILAR TO JEDEC MS-095-AH
 6. N = NUMBER OF PINS

200 SAN GABRIEL DR. SUNNYVALE CA 94086-7070
 PROPRIETARY INFORMATION

PACKAGE FAMILY OUTLINE: PDIP .300'

1/1

21-0043 B

SECURITY CONTROL NUMBER REV

Maxim cannot assume responsibility for use of any circuitry other than circuitry entirely embodied in a Maxim product. No circuit patent licenses are implied. Maxim reserves the right to change the circuitry and specifications without notice at any time.

12 _____ **Maxim Integrated Products, 120 San Gabriel Drive, Sunnyvale, CA 94086 408-737-7600**

Mouser Electronics

Authorized Distributor

Click to View Pricing, Inventory, Delivery & Lifecycle Information:

[Analog Devices Inc.:](#)

[MAX7426CPA+](#) [MAX7426CUA+](#) [MAX7426CUA+T](#) [MAX7426EUA+T](#) [MAX7427CPA+](#) [MAX7427CUA+](#)
[MAX7427CUA+T](#) [MAX7427EUA+T](#) [MAX7426EUA+](#) [MAX7427EUA+](#)